

Fronius Symo

3.0-3-S / 3.7-3-S / 4.5-3-S

3.0-3-M / 3.7-3-M / 4.5-3-M

5.0-3-M / 6.0-3-M / 7.0-3-M

8.2-3-M

10.0-3-M / 12.5-3-M / 15.0-3-M

17.5-3-M / 20.0-3-M

Fronius Eco

25.0-3-S / 27.0-3-S

Operating Instructions

EN

Grid-connected inverter

Istruzioni per l'uso

IT

Inverter per impianti fotovoltaici collegati alla rete

Manual de instruções

PT-BR

Retificador alternado acoplado à rede



Dear reader,

Introduction

Thank you for the trust you have placed in our company and congratulations on buying this high-quality Fronius product. These instructions will help you familiarise yourself with the product. Reading the instructions carefully will enable you to learn about the many different features it has to offer. This will allow you to make full use of its advantages.

Please also note the safety rules to ensure greater safety when using the product. Careful handling of the product will repay you with years of safe and reliable operation. These are essential prerequisites for excellent results.

Explanation of safety symbols



DANGER! Indicates immediate and real danger. If it is not avoided, death or serious injury will result.



WARNING! Indicates a potentially dangerous situation. Death or serious injury may result if appropriate precautions are not taken.



CAUTION! Indicates a situation where damage or injury could occur. If it is not avoided, minor injury and/or damage to property may result.



NOTE! Indicates a risk of flawed results and possible damage to the equipment.

IMPORTANT! Indicates tips for correct operation and other particularly useful information. It does not indicate a potentially damaging or dangerous situation.

If you see any of the symbols depicted in the "Safety rules" chapter, special care is required.

Contents

Safety rules	7
General	7
Environmental conditions	7
Qualified service engineers	8
Noise emission values	8
EMC measures	8
Disposal	8
Data protection	8
Copyright	9
General	10
Device concept	10
Proper use	11
Warning notices on the device	11
Notes regarding dummy devices	12
String fuses	12
Criteria for selecting the right string fuses	13
Data communication and Solar Net	14
Fronius Solar Net and data interface	14
Data communication area	14
Description of the 'Fronius Solar Net' LED	15
Example	16
Explanation of the multifunction current interface	16
Fronius Datamanager 2.0	18
Controls, connections and displays on the Fronius Datamanager	18
Fronius Datamanager during the night or when the available DC voltage is insufficient	20
Using for the first time	21
Further information on Fronius Datamanager 2.0	23
Controls and indicators	24
Controls and indicators	24
Display	25
Navigation at the menu level	26
Activate display backlighting	26
Automatic deactivation of display backlighting / choose 'NOW' menu item	26
Open menu level	26
Values displayed in the NOW menu item	26
Values displayed in the LOG menu item	27
SETUP menu item	28
Initial setting	28
Software updates	28
Navigating in the SETUP menu item	28
Setting entries on the Setup menu, general	29
Application example: Setting the time	29
Menu items in the Set-up menu	31
Standby	31
DATCOM	31
USB	32
Relays	33
Energy-Manager(in Relay menu item)	34
Time / Date	35
Display settings	35
Energy yield	36
Fan	37
The INFO menu item	38
Measured values	38
PSS status	38
Grid status	38
Device information	38
Version	39
Switching the key lock on and off	40
General	40

Switching the key lock on and off.....	40
USB Stick as a Data Logger and for Updating Inverter Software	41
USB flash drive as a datalogger	41
Suitable USB flash drives	41
USB flash drive for updating the inverter software.....	42
Remove USB stick	42
The Basic menu	43
Access the Basic menu.....	43
Items on the Basic menu	44
Settings if the "DC OVP" option is installed	44
Status diagnostics and troubleshooting	45
Displaying status codes	45
Total failure of the display	45
Class 1 status codes.....	45
Class 3 status codes.....	45
Status codes – Class 4	46
Status codes – Class 5	49
Class 6 status codes.....	50
Status codes – Class 7	50
Class 10 - 12 status codes.....	52
Customer service	52
Operation in dusty environments	53
Technical data.....	54
Fronius Symo dummy	61
Explanation of footnotes	61
Applicable standards and guidelines	61
Warranty terms and conditions, and disposal	62
Fronius manufacturer's warranty	62
Disposal	62

Safety rules

General



The device is manufactured using state-of-the-art technology and according to recognised safety standards. If used incorrectly or misused, however, it can cause:

- injury or death to the operator or a third party,
- damage to the device and other material assets belonging to the operator,
- inefficient operation of the device.

All persons involved in commissioning, maintaining and servicing the device must

- be suitably qualified,
- have knowledge of and experience in dealing with electrical installations and
- read and follow these operating instructions carefully.

The operating instructions must always be at hand wherever the device is being used. In addition to the operating instructions, attention must also be paid to any generally applicable and local regulations regarding accident prevention and environmental protection.

All safety and danger notices on the device

- must be in a legible state,
- must not be damaged,
- must not be removed,
- must not be covered, pasted or painted over.

The terminals can reach high temperatures.



Only operate the device when all protection devices are fully functional. If the protection devices are not fully functional, there is a risk of

- injury or death to the operator or a third party,
- damage to the device and other material assets belonging to the operator,
- inefficient operation of the device.

Any safety devices that are not functioning properly must be repaired by a suitably qualified engineer before the device is switched on.

Never bypass or disable protection devices.

For the location of the safety and danger notices on the device, refer to the "General" section in the operating instructions for the device.

Before switching on the device, rectify any faults that could compromise safety.

This is for your personal safety!

Environmental conditions



Operation or storage of the device outside the stipulated area will be deemed as "not in accordance with the intended purpose". The manufacturer shall not be held liable for any damage arising from such usage.

For exact information on permitted environmental conditions, please refer to the "Technical data" in the operating instructions.

Qualified service engineers



The servicing information contained in these operating instructions is intended only for the use of qualified service engineers. An electric shock can be fatal. Do not perform any actions other than those described in the documentation. This applies even if you are qualified to do so.



All cables and leads must be secure, undamaged, insulated and adequately dimensioned. Loose connections, scorched, damaged or inadequately dimensioned cables and leads must be immediately repaired by authorised personnel.



Maintenance and repair work must only be carried out by authorised personnel.

It is impossible to guarantee that bought-in parts are designed and manufactured to meet the demands made of them, or that they satisfy safety requirements. Use only original spare parts (also applies to standard parts).

Do not carry out any modifications, alterations, etc. to the device without the manufacturer's consent.

Components that are not in perfect condition must be changed immediately.

Noise emission values



The maximum sound power level of the inverter is specified in the Technical Data.

The device is cooled as quietly as possible with the aid of an electronic temperature control system; this depends on the amount of converted power, the ambient temperature, the level of soiling of the device, etc.

It is not possible to provide a workplace-related emission value for this device because the actual sound pressure level is heavily influenced by the installation situation, the power quality, the surrounding walls and the properties of the room in general.

EMC measures



In certain cases, even though a device complies with the standard limit values for emissions, it may affect the application area for which it was designed (e.g. when there is sensitive equipment at the same location, or if the site where the device is installed is close to either radio or television receivers). If this is the case, then the operator is obliged to take appropriate action to rectify the situation.

Disposal

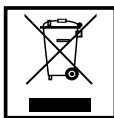

To comply with the European Directive 2002/96/EC on Waste Electrical and Electronic Equipment and its implementation as national law, electrical equipment that has reached the end of its life must be collected separately and returned to an approved recycling facility. Any device that you no longer require must either be returned to your dealer or given to one of the approved collection and recycling facilities in your area. Ignoring this European Directive may have potentially adverse effects on the environment and your health!

Data protection

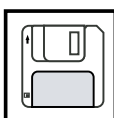

The user is responsible for the safekeeping of any changes made to the factory settings. The manufacturer accepts no liability for any deleted personal settings.

Copyright



Copyright of these operating instructions remains with the manufacturer.

The text and illustrations are all technically correct at the time of printing. We reserve the right to make changes. The contents of the operating instructions shall not provide the basis for any claims whatsoever on the part of the purchaser. If you have any suggestions for improvement, or can point out any mistakes that you have found in the instructions, we will be most grateful for your comments.

General

Device concept

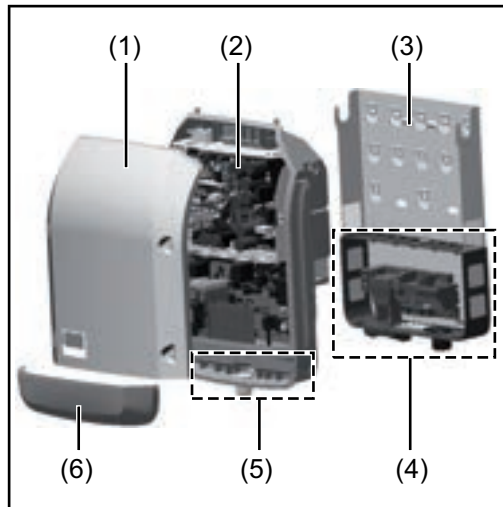

Device design:

- (1) Housing lid
- (2) Inverter
- (3) Wall bracket
- (4) Connection area incl. DC main switch
- (5) Data communication area
- (6) Data communication cover

The inverter converts the direct current created in the solar modules into alternating current. This alternating current is fed into the public grid synchronously with the grid voltage.

The inverter has been developed exclusively for use in grid-connected photovoltaic systems; it is impossible to generate energy independently of the public grid.

Thanks to its design and the way it works, the inverter is extremely safe both to install and to operate.

The inverter automatically monitors the public grid. In the event of abnormal grid conditions, the inverter ceases operating immediately and stops feeding power into the grid (e.g. if the grid is switched off, if there is an interruption, etc.).

Grid monitoring involves monitoring voltage, frequency and the stand-alone situation.

The inverter operates fully automatically. As soon after sunrise as there is sufficient energy available from the solar modules, the inverter starts monitoring the grid. When insolation has reached a sufficient level, the inverter starts feeding energy into the grid.

The inverter operates in such a way that the maximum possible amount of power is obtained from the solar modules.

As soon as the power available has fallen below the level at which energy can be fed into the grid, the inverter disconnects the power electronics completely from the grid and stops running. It retains all its settings and stored data.

If the inverter becomes too hot, it automatically reduces the current output power in order to protect itself.

Reasons for the inverter becoming too hot include the ambient temperature being too high or inadequate heat dissipation (e.g. if it is installed in a switch cabinet without suitable heat dissipation).

The Fronius Eco does not have an internal boost converter. This results in certain restrictions in the choice of solar module and string. The minimum DC input voltage ($U_{DC \min}$) depends on the grid voltage. On the other hand, a highly optimised device is then available for the appropriate application.

Proper use

The solar inverter is intended exclusively to convert direct current from solar modules into alternating current and to feed this into the public grid.

Utilisation not in accordance with the intended purpose comprises:

- utilisation for any other purpose or in any other manner
- making any modifications to the inverter that have not been expressly approved by Fronius
- the installation of parts that are not distributed or expressly approved by Fronius.

Fronius shall not be liable for any damage resulting from such action.
No warranty claims will be entertained.

Proper use includes:

- carefully reading and obeying all the instructions and all the safety and danger notices in the operating instructions
- performing all stipulated inspection and maintenance work
- installation as specified in the operating instructions

When designing the photovoltaic system, ensure that all of its components are operated within their permitted operating ranges at all times.

Observe all the measures recommended by the solar module manufacturer to ensure the lasting maintenance of the properties of the solar module.

Obey the regulations of the energy supply company regarding feeding energy into the grid.

Warning notices on the device

There are warning notices and safety symbols on and in the inverter. These warning notices and safety symbols must not be removed or painted over. They warn against operating the device incorrectly, as this may result in serious injury and damage.

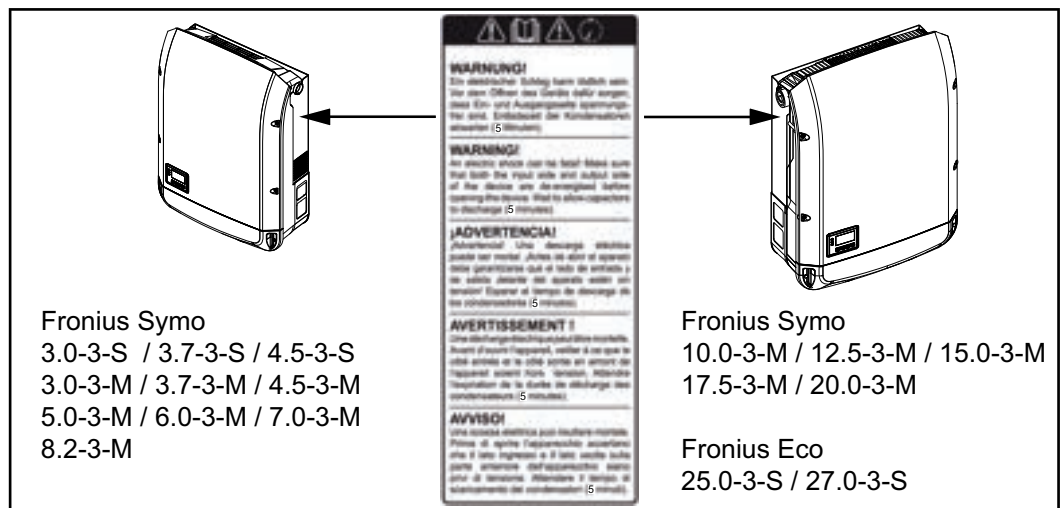

Safety symbols:



Risk of serious injury and damage due to incorrect operation



Do not use the functions described here until you have fully read and understood the following documents:

- these operating instructions
- all the operating instructions for the system components of the photovoltaic system, especially the safety rules



Dangerous electrical voltage



Wait for the capacitors to discharge.

Text of the warning notices:

WARNING!

An electric shock can be fatal. Make sure that both the input side and output side of the device are de-energised before opening the device. Wait for the capacitors to discharge (5 minutes).

Notes regarding dummy devices

A dummy device is not suitable for connecting operationally to a photovoltaic system, and must only ever be used for demonstration purposes.

IMPORTANT! Never connect DC cables to the DC connection sockets on a dummy device.

The connection of de-energised cables or sections of cable for demonstration purposes is permissible.

A dummy device can be recognised by its device rating plate:

					www.fronius.com		N 28324		
Model No.		OVC1		OVC2		UAC nom		220 V	230 V
Part No.		VLAN / LAN / Webservice		fAC nom		50 / 60 Hz		Grid	
Ser. No.		IEC62109-1/-2 / EN61000-3-2/-3 / EN61000-6-2/-3 / EN62233		UAC nom		6.8 A		1~NPE	
VDE-AR-N 4105		DIN VDE V 0126-1-1		UAC max		9.0 A		IAC nom	
CEI 0-21		Safety Class 1		IAC max		4500 VA		IAC nom	
IP 65				S _{nom} / S _{max}		4500 VA		6.8 A	
				cos φ		0.7-1 ind./cap.		IAC max	
				P _{max} (cosφ=0.95 / cosφ=1)		4275 W / 4500 W		S _{nom} / S _{max}	
				UDC mpp		150 - 800 V		4500 VA	
				UDC min / max		150 - 1000 V			
				IDC max		16.0 A			
				Isc pv		24.0 A			

Example: Device rating plate of a dummy device

String fuses



WARNING! An electric shock can be fatal. Danger from voltage at the fuse holders. The fuse holders are live when a voltage is present on the DC connection of the inverter, even when the DC switch is switched off. Make sure that the DC side is de-energised before carrying out any work on the inverter's fuse holders.

String fuses are used in the Fronius Eco to provide additional protection for the solar modules.

The maximum short circuit current I_{SC} , the maximum module return current I_R or the maximum string fuse rating specified in the module data sheet of the respective solar module is crucial in affording the solar modules the correct fuse protection.

The maximum short circuit current I_{SC} per terminal is 12 A.

Where necessary, a tripping current higher than 12 A may be selected for the string fuses.

A DC Connector Kit (item number: 4,251,015) must be used if the inverter is operated with an external string combiner box. In this case the solar modules are protected externally in the string combiner box, and the metal bolts need to be used in the inverter.

The national regulations in respect of fuse protection must be observed. The electrical engineer carrying out the installation is responsible for the correct choice of string fuses.

NOTE! To avoid the risk of a fire, only replace faulty fuses with new ones of the same rating.

As an option, the inverter can be supplied with the following fuses:

- 6 x 15 A string fuses on the DC+ input and 6 x metal pins on the DC- input
- 12 x metal pins

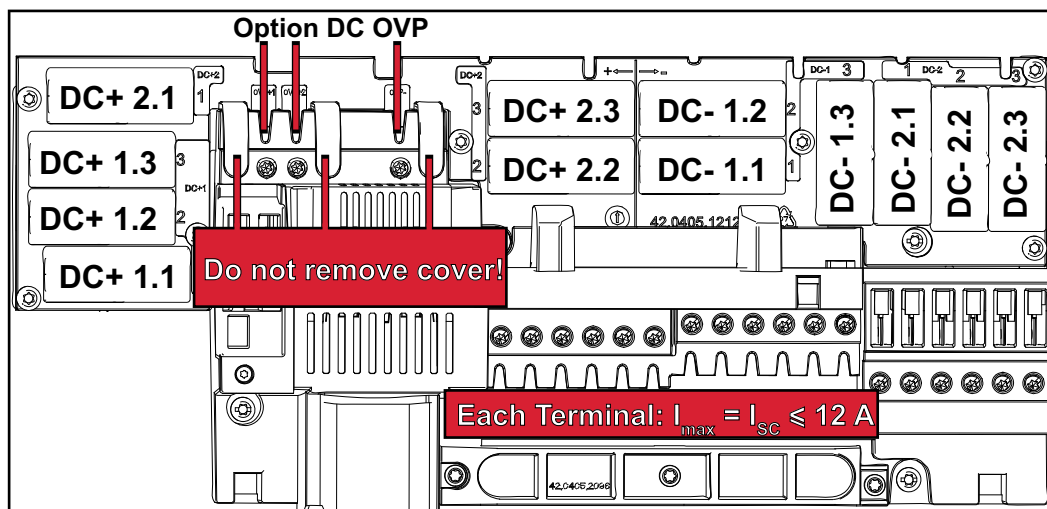

Criteria for selecting the right string fuses

The following criteria must be met for each solar module string when selecting suitable fuses:

- $I_N > 1.8 \times I_{SC}$
- $I_N < 2.4 \times I_{SC}$
- $U_N \geq$ max. input voltage of the inverter used
- Fuse dimensions: diameter 10 x 38 mm

- I_N Nominal current of fuse
- I_{SC} Short circuit current for standard test conditions (STC) according to the solar module data sheet
- U_N Rated voltage of fuse

NOTE! The nominal current rating of the fuse must not exceed the maximum fuse protection specified in the data sheet supplied by the solar module manufacturer. If a maximum fuse protection is not specified, then this information must be requested from the solar module manufacturer.

Data communication and Solar Net

Fronius Solar Net and data interface

Fronius Solar Net was developed to make system add-ons flexible to use in a variety of different applications. Fronius Solar Net is a data network that enables multiple inverters to be linked up using system add-ons.

It is a bus system that uses a ring topology. One suitable cable is sufficient for communication between one or several inverters that are connected on the Fronius Solar Net using a system add-on.

Fronius Solar Net automatically recognises a wide variety of system add-ons.

In order to distinguish between several identical system add-ons, each one must be assigned a unique number.

Similarly, every inverter on the Fronius Solar Net must be assigned a unique number. Refer to the section entitled 'The SETUP menu item' for instructions on how to assign a unique number.

More detailed information on the individual system add-ons can be found in the relevant operating instructions or on the internet at www.fronius.com

More detailed information on cabling DATCOM components can be found at:



→ <http://www.fronius.com/QR-link/4204101938>

Data communication area

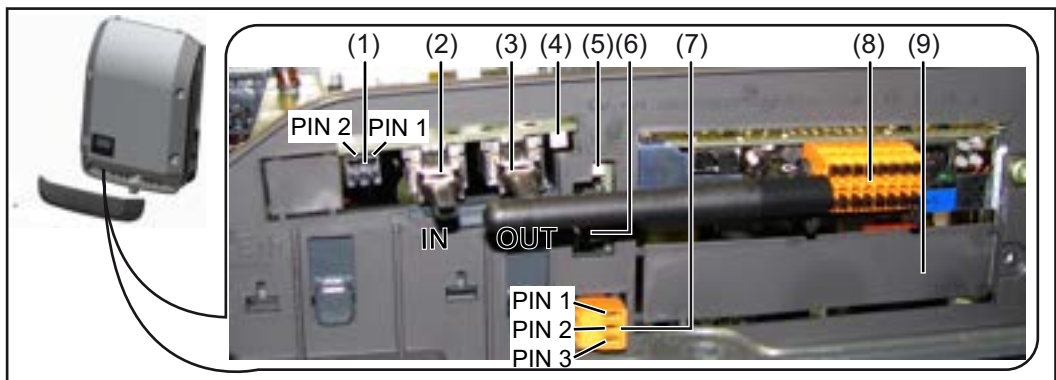

Depending on the model, the inverter may be equipped with the Fronius Datamanager plug-in card.

Item	Designation
(1)	<p>Switchable multifunction current interface. For more details, refer to the section below entitled "Explanation of the multifunction current interface"</p> <p>Use the 2-pin mating connector supplied with the inverter to connect to the multifunction current interface.</p>
(2)	Fronius Solar Net connection / interface protocol IN
(3)	<p>Fronius Solar Net connection / interface protocol OUT</p> <p>'Fronius Solar Net' / interface protocol input and output for connecting to other DATCOM components (e.g. inverter, sensor box, etc.)</p> <p>If several DATCOM components are linked together, a terminating plug must be connected to every free IN or OUT connection on a DATCOM component. For inverters with a Fronius Datamanager plug-in card, two terminating plugs are supplied with the inverter.</p>
(4)	<p>The 'Solar Net' LED indicates whether the Fronius Solar Net power supply is available</p>
(5)	<p>The 'Data transfer' LED flashes while the USB flash drive is being accessed. The USB flash drive must not be removed while recording is in progress.</p>
(6)	<p>USB A socket for connecting a USB flash drive with maximum dimensions of 65 x 30 mm (2.6 x 2.1 in.)</p> <p>The USB flash drive can function as a datalogger for an inverter. The USB flash drive is not included in the scope of supply of the inverter.</p>
(7)	<p>Floating switch contact with mating connector</p> <p>max. 250 V AC / 4 A AC max. 30 V DC / 1 A DC max. 1.5 mm² (AWG 16) cable cross-section</p> <p>Pin 1 = NO contact (Normally Open) Pin 2 = C (Common) Pin 3 = NC contact (Normally Closed)</p> <p>Use the mating connector supplied with the inverter to connect to the floating switch contact.</p>
(8)	<p>Fronius Datamanager with WLAN antenna or cover for option card compartment</p>
(9)	Cover for option card compartment

Description of the 'Fronius Solar Net' LED

The 'Solar Net' LED is on:

the power supply for data communication within the Fronius Solar Net / interface protocol is OK

The 'Solar Net' LED flashes briefly every 5 seconds:

data communication error in the Fronius Solar Net

- Overcurrent (current flow > 3 A, e.g. resulting from a short circuit in the Fronius Solar Net ring)
- Undervoltage (not a short circuit, voltage in Fronius Solar Net < 6.5 V, e.g. if there are too many DATCOM components on the Fronius Solar Net and not enough electrical power is available)

In this case, power for the DATCOM components must be supplied by connecting an

additional power supply to one of the DATCOM components.

To detect the presence of an undervoltage, check some of the other DATCOM components for faults as required.

After cutting out because of overcurrent or undervoltage, the inverter attempts to restore the power supply in the Fronius Solar Net every 5 seconds while the fault is still present.

Once the fault is rectified, power to the Fronius Solar Net will be restored within 5 seconds.

Example

Recording and archiving data from the inverter and sensor using a Fronius Datamanager and a Fronius Sensor Box:

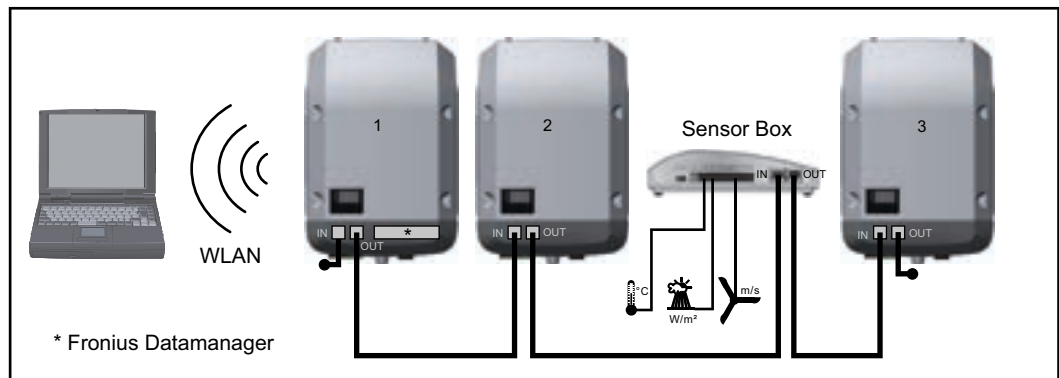

Data network with 3 inverters and a Fronius Sensor Box:

- Inverter 1 with Fronius Datamanager
- Inverters 2 and 3 without Fronius Datamanager!

● = Terminating plug

The external communication (Fronius Solar Net) takes place on the inverter via the data communication area. The data communication area contains two RS 422 interfaces as inputs and outputs. RJ45 plug connectors are used to make the connection.

IMPORTANT! Since the Fronius Datamanager functions as a datalogger, the Fronius Solar Net ring must not include any other datalogger.

There must only be one Fronius Datamanager in each Fronius Solar Net ring.

Fronius Symo 3 - 10 kW: Any other Fronius Datamanagers must be removed and the unoccupied option card slot sealed off using the blanking cover (42,0405,2020 - available from Fronius as an optional extra); alternatively, use an inverter without Fronius Datamanager (light version).

Fronius Symo 10 - 20 kW, Fronius Eco: Any other Fronius Datamanagers must be removed and the unoccupied option card slot sealed off by replacing the cover (item no. 42,0405,2094); alternatively, use an inverter without Fronius Datamanager (light version).

Explanation of the multifunction current interface

Various wiring variants can be connected to the multifunction current interface. However, these cannot be operated simultaneously. For example, if an S0 meter is connected to the multifunction current interface, it is not possible to connect a signal contact for overvoltage protection (or vice versa).

Pin 1 = measurement input: max. 20 mA, 100 Ohm measurement resistor (load impedance)

Pin 2 = max. short circuit current 15 mA, max. open circuit voltage 16 V DC or GND

Wiring diagram variant 1: Signal contact for overvoltage protection

Depending on the setting in the Basic menu, the DC OVP option (overvoltage protection) either outputs a warning or an error on the display. Further information on the DC OVP option can be found in the installation instructions.

Wiring diagram variant 2: S0 meter

A meter for recording the self-consumption of each S0 can be connected directly to the inverter. This S0 meter can be positioned directly at the feed-in point or in the consumption branch. As one of the settings on the Fronius Datamanager website, a dynamic power reduction can be set under the "EVU Editor" menu subitem (see Fronius Datamanager operating instructions under www.fronius.com/QR-link/4204260173EA)

IMPORTANT! In order to connect an S0 meter to the inverter, it may be necessary to update the inverter firmware.

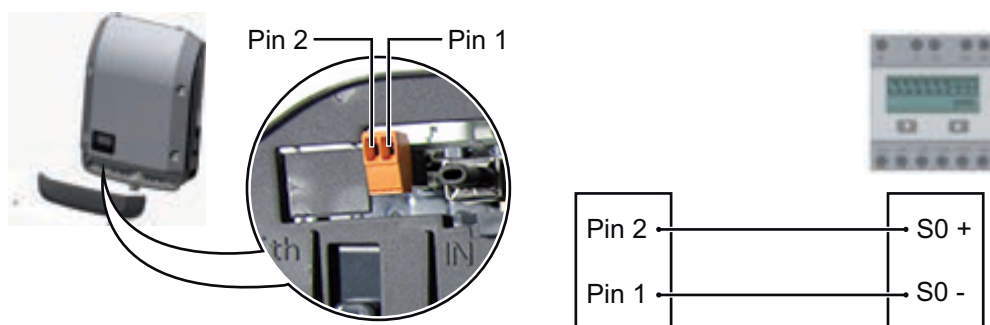

Requirements for the S0 meter:

- Must comply with the IEC62053-31 Class B standard
- Max. voltage 15 V DC
- Max. current when ON 15 mA
- Min. current when ON 2 mA
- Max. current when OFF 0.15 mA

Recommended max. pulse rate of the S0 meter:

PV output kWp [kW]	Max. pulse rate per kWp
30	1000
20	2000
10	5000
≤ 5.5	10,000

Fronius Datamanager 2.0

Controls, connections and displays on the Fronius Datamanager

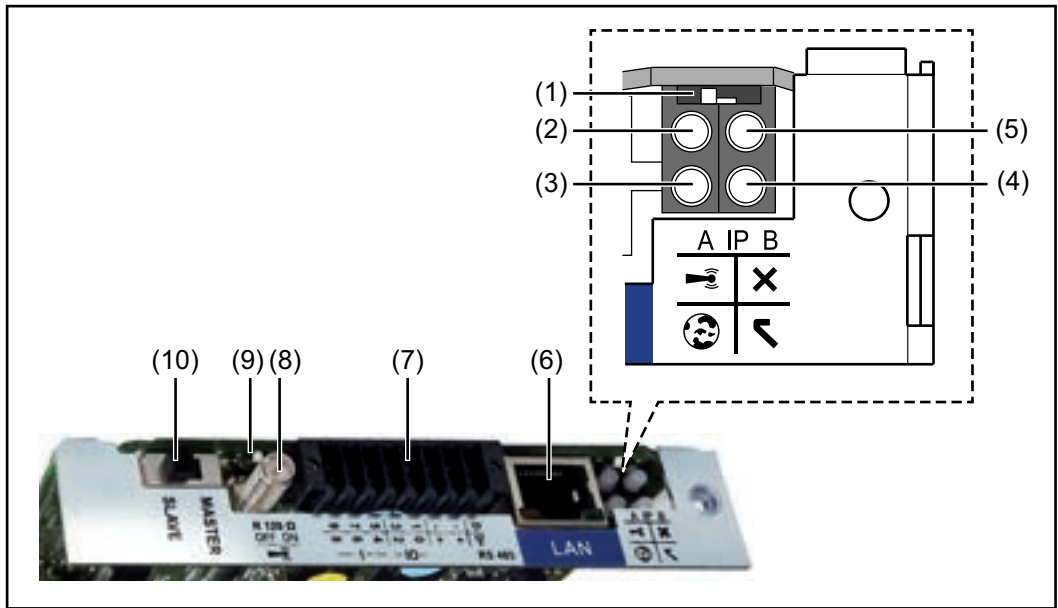

No. Function

(1) IP switch

For switching the IP address:

Switch position A

Default IP address with opening of the WLAN access point

Fronius Datamanager 2.0 uses the set IP address 169.254.0.180 to establish a direct connection to a PC via LAN.

Setting the IP switch to position A also opens an access point to enable a direct WLAN connection to the Fronius Datamanager 2.0.

Access data for this access point:

Network name: FRONIUS_240.XXXXXX

Code: 12345678

Access to the Fronius Datamanager 2.0 is possible:

- Using the DNS name "http://datamanager"
- Using the IP address 169.254.0.180 for the LAN interface
- Using the IP address 192.168.250.181 for the WLAN access point

Switch position B

Assigned IP address

The Fronius Datamanager 2.0 uses an assigned IP address (factory setting dynamic (DHCP))

The IP address can be set on the Fronius Datamanager 2.0 website.

No. Function**Int./ext. power supply**

- GND
- + U_{int} / U_{ext}
Internal voltage output 12.8 V
or
input for an external supply voltage
>12.8 - 24 V DC (+ 20%)

Digital inputs: 0 - 3, 4 - 9

Voltage level: low = min. 0 V - max. 1.8 V; high = min. 3 V - max. 24 V DC (+ 20%)
Input currents: dependent on input voltage; input resistance = 46 kOhm

Digital outputs: 0 - 3

Switching capacity when power is supplied by the Fronius Datamanager 2.0 plug-in card: 3.2 W in total for all 4 digital outputs

Switching capacity when power is supplied by an external power supply delivering min. 12.8 - max. 24 V DC (+ 20%), connected to U_{int} / U_{ext} and GND: 1 A, 12.8 - 24 V DC (depending on external power supply) for each digital output

The connection to the I/Os is established via the mating connector supplied.

(8) Antenna socket

This is where the WLAN antenna is connected

(9) Modbus termination switch (for Modbus RTU)

Internal bus terminator with 120 ohm resistor (yes/no)

Switch in "on" position: 120 ohm terminating resistor active

Switch in "off" position: no terminating resistor active



IMPORTANT! On an RS485 bus, the terminating resistor on the first and last device must be active.

(10) Fronius Solar Net Master / Slave switch

To switch from master to slave mode within a Fronius Solar Net ring

IMPORTANT! In slave mode, all the LEDs on the Fronius Datamanager 2.0 plug-in card are off.

Fronius Datamanager during the night or when the available DC voltage is insufficient

The Night Mode parameter under "Display Settings" in the Setup menu is preset to OFF in the factory.

For this reason the Fronius Datamanager cannot be accessed during the night or when the available DC voltage is insufficient.

To nevertheless activate the Fronius Datamanager, switch the inverter off and on again at the mains and press any key on the inverter display within 90 seconds.

See also the chapters on "The Setup menu items", "Display settings" (Night Mode).

Using for the first time



NOTE! Starting the Fronius Datamanager 2.0 for the first time can be made significantly easier with the aid of the Fronius Solar.web App. The Fronius Solar.web App is available in the relevant App store.

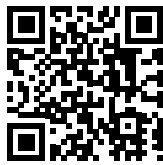

- When starting Fronius Datamanager 2.0 for the first time,
- the Fronius Datamanager 2.0 plug-in card must be installed in the inverter, or
 - there must be a Fronius Datamanager Box 2.0 in the Fronius Solar Net ring.

IMPORTANT! In order to establish a connection to Fronius Datamanager 2.0, the end device in question (e.g. laptop, tablet, etc.) must be set up as follows:

- "Obtain IP address automatically (DHCP)" must be activated.



NOTE! If the photovoltaic system has only one inverter, steps 1 and 2 below can be skipped. In this case, starting for the first time will commence with step 3.

- 1 Connect inverter with Fronius Datamanager 2.0 or Fronius Datamanager Box 2.0 to the Fronius Solar Net
- 2 When networking several inverters together in Fronius Solar Net: Set the Fronius Solar Net master / slave switch on the Fronius Datamanager 2.0 plug-in card correctly
 - One inverter with Fronius Datamanager 2.0 = master
 - All other inverters with Fronius Datamanager 2.0 = slave (the LEDs on the Fronius Datamanager 2.0 plug-in cards are not illuminated)
- 3 Switch the device to Service mode.
 - Activate the WiFi Access Point via the Setup menu on the inverter.



The inverter establishes the WLAN access point. The WLAN access point remains open for 1 hour.

Installation using the Solar.web App

- 4 Download the Fronius Solar.web App.



- 5 Run the Fronius Solar.web App.

Installation using a web browser

- 4 Connect the end device to the WLAN access point

SSID = Fronius_240.xxxxx (5-8 digits)

- Search for a network with the name "Fronius_240.xxxxx"
- Establish a connection to this network.
- Enter the password 12345678.

(Alternatively, connect the end device and inverter using an Ethernet cable.)

- 5 Enter the following in the browser:
<http://datamanager>

or

192.168.250.181 (IP address for WLAN connection)

or

169.254.0.180 (IP address for LAN connection).

The Setup wizard start page is displayed.

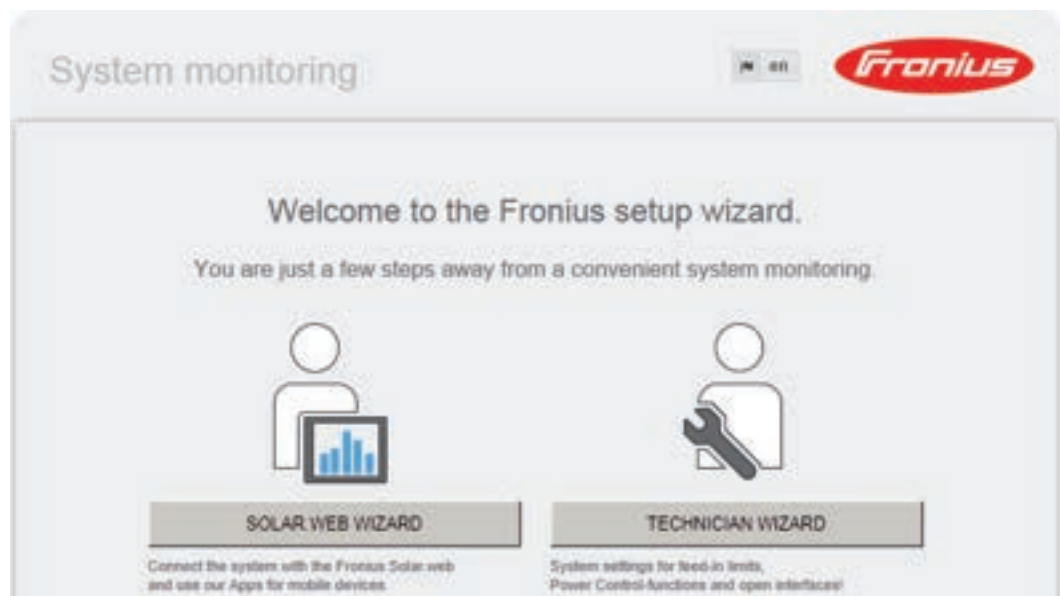

The technician wizard is intended for the installer and contains standard-specific settings. Running the technician wizard is optional.

If the technician wizard is run, it is vital to note the service password that is issued. This service password is necessary for setting the EVU Editor menu item.

If the technician wizard is not run, no specifications regarding power reduction are set.

Running the Solar Web wizard is mandatory.

- 6 Run the Solar Web wizard and follow the instructions.

The Fronius Solar.web homepage is displayed,

or

the Fronius Datamanager 2.0 web page is displayed.

7 Where necessary, run the technician wizard and follow the instructions

Further information on Fronius Datamanager 2.0

Further information on the Fronius Datamanager 2.0 and other start-up options can be found at:



→ <http://www.fronius.com/QR-link/4204260191EA>

Controls and indicators

Controls and indicators

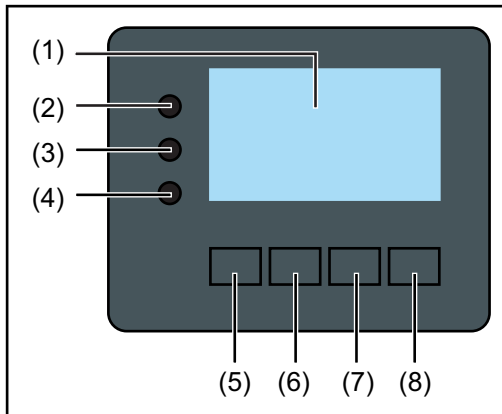

Item	Description
(1)	Display for displaying values, settings and menus

Monitoring and status LEDs

(2)	<p>General status LED on steady,</p> <ul style="list-style-type: none"> - if a status code is being displayed on the monitor (red for error, orange for warning) - if the process of feeding energy into the grid is interrupted - while error handling (the inverter waits for an acknowledgement or for an error to be rectified)
(3)	<p>Startup LED (orange) on steady if</p> <ul style="list-style-type: none"> - the inverter is in its automatic startup or self-test phase (as soon after sunrise as the solar modules are delivering sufficient power) - the inverter has been switched to standby mode in the setup menu (= feeding energy into the grid switched off manually) - the inverter software is being updated
(4)	<p>Operating status LED (green) on steady,</p> <ul style="list-style-type: none"> - if the PV system is working correctly after the inverter's automatic startup phase - all the time while energy is being fed into the grid

Function keys - allocated different functions depending on the selection:

(5)	'Left/up' key for navigating to the left and up
(6)	'Down/right' key for navigating down and to the right
(7)	'Menu/Esc' key for switching to the menu level for quitting the Setup menu
(8)	'Enter' key for confirming a selection

The keys operate capacitively. Exposure to water may impair their function. If necessary, wipe the keys dry with a cloth to ensure optimum functionality.

Display

Power for the display comes from the mains voltage. Depending on the setting selected in the Setup menu, the display can be kept on all day.

IMPORTANT! The display on the inverter is not a calibrated measuring device. A slight inaccuracy in comparison with the energy meter used by the power supply company is intrinsic to the system. A calibrated meter will be needed to calculate the bills for the power supply company.

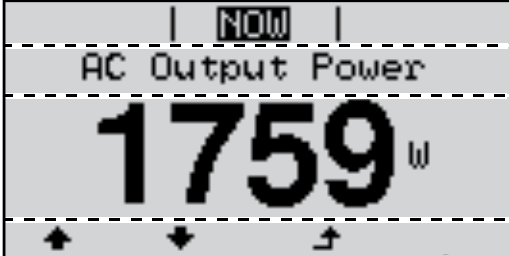
	Menu item
	Parameter declaration
	Display of values, units and status codes
	Function key functions

Display areas in Display mode

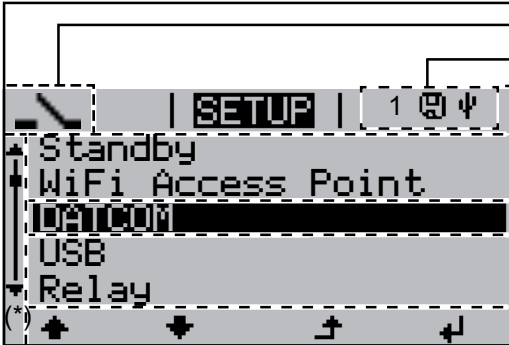
	Energy-Manager (**) Inv. no. Save symbol USB conn.(***)
	Menu item
	Previous menu items
	Currently selected menu item
	Next menu items
	Function key functions

Display areas in Setup mode

- (*) Scroll bar
- (**) The Energy Manager symbol is displayed when the Energy Manager function is activated
- (***) Inv. no. = Inverter DATCOM number,
Save symbol - appears briefly while set values are being saved,
USB connection - appears if a USB flash drive has been connected

Navigation at the menu level

Activate display backlighting

1 Press any key

The display backlighting is activated.

There is an option under 'Display Settings' in the SETUP menu to set the display backlighting so that it is on all the time or off all the time.

Automatic deactivation of display backlighting / choose 'NOW' menu item

If no key is pressed for 2 minutes,

- the display backlighting switches off automatically and the inverter goes to the 'NOW' menu item (assuming the display backlighting is set to automatic).
- The selection of the 'NOW' menu item can happen from any position on the menu level with the exception of the item 'Standby' on the Setup menu.
- The amount of energy currently fed in is displayed.

Open menu level

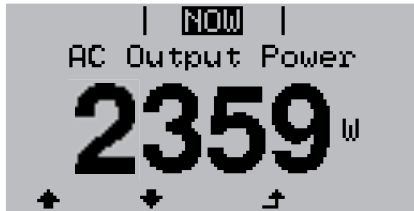

1 Press the 'Menu' key



The display switches to the menu level.

2 Use the 'Left' or 'Right' keys to select the desired menu item

3 Press the 'Enter' key to select the desired menu item

The menu items

- **NOW** displays real-time values
- **LOG** data recorded today, during the current calendar year and since the inverter was first commissioned
- **GRAPH** Day characteristic displays a plot showing the power output during the day. The time axis is scaled automatically. Press the 'Back' key to close the display
- **SETUP** Setup menu
- **INFO** Information about the device and the software

Values displayed in the NOW menu item

Output power (W) - depending on the device type (MultiString), two output powers (PV1 / PV2) are displayed when the Enter key is pressed

AC reactive power (VAr)

Grid voltage (V)

Output current (A)

Grid frequency (Hz)

PV array voltage (V) - from U PV1 and U PV2 if present

PV array current (A) - from I PV1 and I PV2 if present

Fronius Eco: The total current from both measuring channels is displayed. Both channels are shown separately in SolarWeb.

Time date - Time and date on the inverter or in the Fronius Solar Net ring

**Values displayed
in the LOG menu
item**

Energy fed in (kWh / MWh)

Energy fed into the grid during the period in question

There may be discrepancies with values displayed on other measuring instruments because of differences in measuring methods. As far as the billing of the energy fed in is concerned, the only binding display values are those produced by the calibrated measuring device provided by the electricity supply company.

Max. output power (W)

Largest amount of energy fed into the grid during the period in question

Yield

Amount of money earned during the period in question (currency and conversion factor can be selected in the Setup menu)

Like the energy supplied figure, the yield figure may also exhibit discrepancies with other measured values.

The 'Setup Menu' section explains how to select a currency and charge rate. The factory setting depends on the respective country setup.

Max. AC grid voltage (V)

Highest AC grid voltage measured during the period in question

Maximum solar voltage (V)

Highest solar module voltage measured during the period in question

Operating Hours

Length of time the inverter has been working (HH:MM).

IMPORTANT! A prerequisite for the correct display of day and year values is that the time is set correctly.

SETUP menu item

Initial setting

The inverter is pre-configured and ready to use. There is no need to enter any initial settings before using it to feed energy into the grid, as this is a fully-automated process.

The SETUP menu item allows the initial settings of the inverter to be changed easily to bring it in line, as closely as possible, with the preferences and requirements of the user.

Software updates



NOTE! As a result of software updates, you may find that your device has certain functions that are not described in these operating instructions, or vice versa. Certain illustrations may also differ slightly from the actual controls on your device, but these controls function in exactly the same way.

Navigating in the SETUP menu item

Enter the SETUP menu item

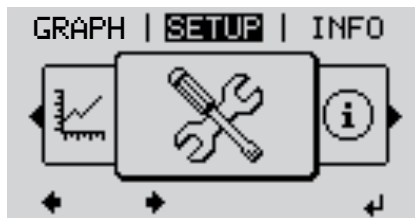

- 1 In the menu level, use the 'Left' or 'Right' keys to select the 'SETUP' menu item
- 2 Press 'Enter'



The first entry under the SETUP menu item is displayed: 'Standby'

Scrolling between the entries



- 3 Use the 'Up' and 'Down' keys to move between the available entries

Exiting an entry

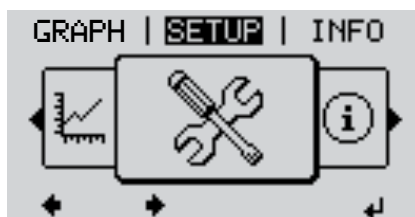

- 4 To exit a menu entry, press the 'Back' key

The menu level appears

If no key is pressed for 2 minutes,

- The inverter switches from wherever it is on the menu level back to the 'NOW' display mode (exception: 'Standby' Setup menu entry),
- the display backlighting goes out.
- the amount of energy currently being fed in is displayed.

Setting entries on the Setup menu, general

- 1** Entering the SETUP menu item
- 2** Use the 'Up' or 'Down' keys to select the desired menu item
 ▲ ▼
- 3** Press 'Enter'
 ↵

The first digit of a value to be set flashes:

- 4** Use the 'Up' or 'Down' keys to select a value for the first digit
 ▲ ▼
- 5** Press 'Enter'
 ↵

The second digit of the value flashes.

- 6** Repeat steps 4 and 5 until ...

the whole value to be set flashes.

- 7** Press 'Enter'
 ↵
- 8** Repeat steps 4 - 6 as required for units or other values that are to be set until the appropriate unit or the value flashes.
- 9** Press the 'Enter' key to save and apply the changes.
 ↵

To discard the changes, press the 'Esc' key.
 ⬆

The currently selected menu item is displayed.

The available settings are displayed:

- 4** Use the 'Up' or 'Down' buttons to select the desired setting
 ▲ ▼
- 5** Press the 'Enter' key to save and apply the setting.
 ↵

To discard the setting, press the 'Esc' key.
 ⬆

The currently selected menu item is displayed.

Application example: Setting the time

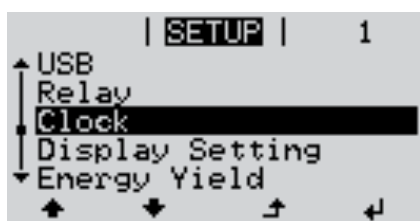

- ▲ ▼ **1** Select 'Time / Date' from the Setup menu
- ↵ **2** Press the 'Enter' key



An overview of the values that can be changed is displayed.

↕ **3** Use the 'Up' or 'Down' keys to select 'Set time'

↵ **4** Press the 'Enter' key

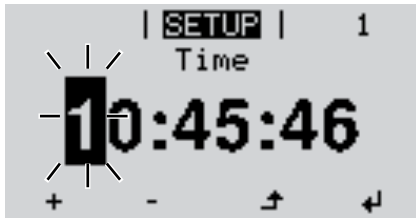

The current time appears. (HH:MM:SS, 24-hour clock), the 'tens' digit for the hour will flash.

+ - **5** Use the 'Up' and 'Down' keys to select a value for the 'tens' digit for the hour

↵ **6** Press the 'Enter' key



The 'units' digit for the hour will flash.

7 Repeat steps 5 and 6 for the 'units' digit for the hour, for the minutes and seconds until...

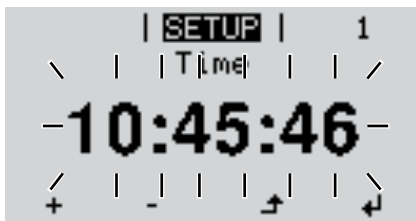

the set time starts flashing.

↵ **8** Press the 'Enter' key



The time is applied and the overview of values that can be changed is displayed.

↶ **4** Press the 'Esc' key



The 'Time / Date' item on the Setup menu appears.

Menu items in the Set-up menu

Standby

Manual activation / deactivation of Standby mode

- No energy is fed into the grid.
- The Startup LED will show steady orange.
- In Standby mode, no other menu item at menu level can be accessed or adjusted.
- The automatic switchover into the 'NOW' display mode after 2 minutes of keyboard inactivity does not occur.
- Standby mode can only be terminated manually by pressing the 'Enter' key.
- Feeding energy into the grid can be resumed at any time (deactivate 'Standby').

Switching off Standby mode (manually switching off feeding energy into the grid):

1 Select the 'Standby' item

2 Press the 'Enter' key

'STANDBY' and 'ENTER' appear alternately on the display.

Standby mode is now active.

The Startup LED shows steady orange.

Resuming feeding energy into the grid:

'STANDBY' and 'ENTER' appear alternately on the display when in Standby mode.

1 Press the 'Enter' key to resume feeding energy into the grid

The 'Standby' menu item is displayed.

At the same time, the inverter enters the startup phase.

The operating state LED shows steady green when feeding energy into the grid has been resumed.

DATCOM

Checking data communications, entering the inverter number, DATCOM night mode, protocol settings

Setting range	Status / inverter number / protocol type
---------------	--

Status

Indicates data communication is taking place via Fronius Solar Net or that a data communications error has occurred

Inverter number

Sets the number (= address) of the inverter in a system with several solar inverters

Setting range	00 - 99 (00 = 100th inverter)
---------------	-------------------------------

Factory setting	01
-----------------	----

IMPORTANT! If a number of inverters are linked together in a data communications system, assign a unique address to each one.

Protocol type

Specifies the communications protocol to be used to transfer the data:

Setting range	Fronius Solar Net / Interface protocol *
---------------	--

* The protocol type 'interface protocol' only functions when there is no Datamanager card in the inverter. All Datamanager cards must be removed from the inverter.

USB

Specification of values in conjunction with a USB stick

Setting range Safely remove hardware / Software update / Logging interval

Safely remove hardware

To remove a USB stick from the USB A socket on the plug-in data communications card without losing any data.

The USB stick can be removed:

- when the OK message appears
- when the 'Data transfer' LED stops flashing or comes on steady

Software Update

To update the inverter software via a USB stick.

Procedure:

- 1** Download the relevant update file 'froxxxxx.upd'
(e.g. from <http://www.fronius.com>; xxxxx stands for the version number)



NOTE! To successfully update the inverter software, the USB stick provided for the purpose must not have a hidden partition or any encryption (see chapter "Suitable USB sticks").

- 2** Save the update file to the highest data level of the USB stick
- 3** Open the data communication area
- 4** Plug the USB stick containing the update file into the USB socket in the data communication area
- 5** Select 'USB' from the Setup menu, followed by 'Update software'
- 6** Press the 'Enter' key
- 7** Wait until the version currently installed on the inverter and the new software version are displayed for comparison:
 - 1st page: Recerbo software (LCD), key controller software (KEY), country setup version (Set)
 - 2nd page: Power stage set software
- 8** Press the 'Enter' key after each page

The inverter starts copying the data.

'UPDATE' and the progress of storing the individual tests expressed in % are displayed until all the data for all the electronic modules has been copied.

Once copying is complete, the inverter updates the electronic modules as required in sequence.

'UPDATE', the affected modules and the update progress in % are displayed.

The final step is for the inverter to update the display.

The display remains dark for approx. 1 minute while the monitoring and status LEDs flash.

Once the software update is complete, the inverter enters its startup phase before going on to start feeding energy into the grid. The USB stick can be unplugged.

When the inverter software is updated, any custom settings that were configured in the Setup menu are retained.

Logging interval

Activate / deactivate the logging function and specify a logging interval

Unit	Minutes
Setting range	30 min. / 20 min./ 15 min./ 10 min./ 5 min./ No log
Factory setting	30 min.
30 min.	The logging interval is 30 minutes; every 30 minutes new logging data will be saved on the USB stick.
20 min.	
15 min.	
10 min.	
5 min.	
No log	No data is saved

IMPORTANT! In order for the logging function to work correctly the time must be set correctly.

Relays

Activate relay, relay settings, relay test

Setting range Relay mode / Relay test / Switch-on point* / Switch-off point*

* these are only shown if the 'E-Manager' function has been activated under 'Relay mode'.

Relay mode

for selecting the different functions of the floating switch contact in the data communication area:

- Alarm function
- Active output
- Energy Manager

Setting range ALL / Permanent / OFF / ON / E-Manager

Factory setting ALL

Alarm function:

Permanent / ALL: Switch the floating switch contact for permanent and temporary service codes (e.g. brief interruption to energy being fed into the grid, a service code occurs a certain number of times a day - can be adjusted in the 'BASIC' menu)

Active output:

ON: The floating NO contact is on all the time the inverter is in operation (as long as the display is not dark or is displaying something).

OFF: The floating NO contact is off.

Energy Manager:

E-Manager: Further details on the 'Energy Manager' function may be found in the "Energy Manager" section.

Relay test

Function test to determine whether the floating switch contact switches

Switch-on point (only if 'Energy Manager' function is activated)

for setting the effective power limit beyond which the floating switch contact is switched on

Factory setting 1000 W

Setting range Switch-off point - max. nominal output of inverter / W / kW

Switch-off point (only if 'Energy Manager' function is activated)

for setting the effective power limit beyond which the floating switch contact is switched off

Factory setting 500

Setting range 0 - Switch-on point / W / kW

Energy-Manager (in Relay menu item)

The 'Energy-Manager' function can be used to activate the floating switch contact in such a way that it functions as an actuator.

Thus a consumer that is connected to the floating switch contact can be controlled by specifying a switch-on or switch-off point that depends on the feed-in power.

The floating switch contact is automatically switched off,

- if the inverter is not feeding any power into the grid,
- if the inverter is manually switched into standby mode,
- if the effective power is < 10% of nominal output,
- in the event of insufficient insolation.

To activate the 'Energy-Manager' function, select 'E-Manager' and press the 'Enter' key. When the 'Energy-Manager' function is running, the 'Energy-Manager' symbol will appear in the top left corner of the display:



when the floating NO contact is off (open contact)



when the floating NO contact is on (closed contact)

To deactivate the 'Energy-Manager' function, select a different function and press the 'Enter' key.

Notes on setting up the switch-on and switch-off points

If the difference between the switch-on and switch-off points is too small, or if there are fluctuations in effective power, the result may be multiple switching cycles.

To avoid switching on and off frequently, the difference between the switch-on and switch-off points should be at least 100 - 200 W.

When choosing the switch-off point the power consumption of the connected consumer should be taken into account.

When choosing the switch-on point, the weather conditions and anticipated insolation should also be taken into account.

Application example

Switch-on point = 2000 W, switch-off point = 1800 W

If the inverter is outputting 2000 W or above, then the floating switch contact on the inverter is switched on.

If the inverter output falls to below 1800 W, the floating switch contact is switched off.

Possible applications:
operating a heat pump or an air-conditioning system using as much self-generated power as possible

Time / Date

Set the time, date and automatic changeover between summer and winter time

Setting range Set time / Set date / Time display format / Date display format / Summer/winter time

Set time

Set the time (hh:mm:ss or hh:mm am/pm – depending on the setting for the time display format)

Set date

Set the date (dd.mm.yyyy or mm/dd/yyyy - depending on the setting for the date display format)

Time display format

For specifying the time display format

Setting range 12hrs / 24hrs
Factory setting Depends on country setup

Date display format

for specifying the date display format

Setting range mm/dd/yyyy / dd.mm.yy
Factory setting Depends on country setup

Summer/winter time

Activate/deactivate automatic changeover between summer and winter time

IMPORTANT! Only use the automatic summer/winter time changeover function if the Fronius Solar Net ring does not include any LAN- or WLAN-compatible system components (e.g. Fronius Datalogger Web, Fronius Datamanager or Fronius Hybridmanager).

Setting range on / off
Factory setting on

IMPORTANT! The time and date must be set accurately in order for the day and year values and for the day characteristic to be displayed correctly.

Display settings

Setting range Language / Night mode / Contrast / Illumination

Language

Set language for display

Setting range German, English, French, Dutch, Italian, Spanish, Czech, Slovak, etc.

Night mode

DATCOM night mode; controls DATCOM and display operation during the night or when the DC voltage is insufficient

Setting range	AUTO / ON / OFF
Factory setting	OFF

AUTO: DATCOM mode is always in effect as long as there is a Datalogger connected in an active and uninterrupted Fronius Solar Net. The display remains dark during the night, but can be activated by pressing any key.

ON: DATCOM mode is always in effect. The inverter supplies 12 V continuously to power the Fronius Solar Net. The display is always active.

IMPORTANT! If DATCOM night mode is set to ON or AUTO when there are Fronius Solar Net components connected, then the inverter's current consumption during the night will increase to around 7 W.

OFF: DATCOM will not run at night, the inverter will not need any AC current in order to supply power to the Fronius Solar Net. The display is switched off during the night and the Fronius Datamanager is not available.

Contrast

Set the contrast on the display

Setting range	0 - 10
Factory setting	5

Since the contrast is temperature-dependent, it may be necessary to adjust the setting under the "Contrast" menu item when the environmental conditions change.

Illumination

Initial setting for display illumination

The "Illumination" menu item only relates to the display backlighting.

Setting range	AUTO / ON / OFF
Factory setting	AUTO

AUTO: The display backlighting is activated by pressing any key. If no key is pressed for 2 minutes, the display backlighting will go off again.

ON: The display backlighting remains permanently on when the inverter is active.

OFF: The display backlighting is permanently switched off.

Energy yield

- Setting
- of the currency
 - of the feed-in tariff

Setting range	Currency / Feed-in tariff
---------------	---------------------------

Currency

Set the currency

Setting range	3 characters, A-Z
---------------	-------------------

Feed-in tariff

Set the remuneration rate for energy fed into the grid

Setting range 2 digits, 3 decimal places

Factory setting (depends on country setup)

Fan

To check that the fan is working correctly

Setting range Test fan #1 / Test fan #2 (depending on the device)

- Use the 'Up' and 'Down' keys to select the desired fan
- Testing of the selected fan is initiated by clicking 'Enter'.
- The fan will continue to run until the operator exits the menu by pressing 'Esc'.

The INFO menu item

Measured values

PV Ins.

Insulation resistance of the PV system

U PV 1 / U PV 2 (U PV 2 is not available on the Fronius Symo 15.0-3 208)

Current DC voltage on the terminals, even if the inverter is feeding no power into the grid whatsoever (from the 1st or 2nd MPP tracker)

GVDPR

Grid voltage-dependent power reduction

Fan #1

Percentage of target output for fan

PSS status

The status of the most recent inverter fault can be displayed.

IMPORTANT! Due to the low level of insolation early in the morning and in the evening, the status codes 306 (Power low) and 307 (DC low) are displayed routinely at these times of day. These status codes do not indicate any kind of fault.

- Press the 'Enter' key to see the status of the power stage set and the most recent fault
 - Use the 'Up' and 'Down' keys to scroll through the list
 - Press the 'Back' key to close the status and fault list
-

Grid status

The five most recent grid faults can be displayed:

- Press the 'Enter' key to see the five most recent grid faults
 - Use the 'Up' and 'Down' keys to scroll through the list
 - Press the 'Back' key to close the grid fault display
-

Device information

For displaying the settings that will be of relevance to a power supply company. The values shown will depend on the country setup or the device-specific settings of the inverter.

Display area	General / Country-specific setting / MPP tracker / Grid monitoring / Grid voltage limits / Grid frequency limits / Q-mode / AC power limit / AC voltage derating / Fault Ride Through
--------------	---

General:	Device type Fam. Serial number
----------	--------------------------------------

Country-specific setting:	Setup - specified country setup Version - version of country setup
---------------------------	---

	Group - group for updating the inverter software
--	--

MPP Tracker:	Tracker 1 Tracker 2 (Fronius Symo only, excluding Fronius Symo 15.0-3 208)
--------------	---

Grid monitoring:	GMTi - start-up time of inverter in s
	GMTr - reconnection time in s following a grid fault
	ULL - mean grid voltage over 10 minutes in V.
	LLTrip - trip time for long-term voltage monitoring
Grid voltage limits:	UILmax - upper inner grid voltage in V
	UILmin - lower inner grid voltage in V
Grid frequency limits:	FILmax - upper inner grid frequency in Hz
	FILmin - lower inner grid frequency in Hz
Q-mode:	Current cos phi power factor setting (e.g. Constant Cos(phi) / Constant Q / Q(U) characteristic / etc.)
AC power limit:	Max. P AC - manual power reduction
AC voltage derating:	Status - ON / OFF voltage-dependent power reduction
	GVDPRe - threshold from which the voltage-dependent power reduction begins
	GVDPRe - reduction gradient used to reduce the power, e.g. 10% per volt above the GVDPRe threshold.
	Message - activates the sending of an info message via Fronius Solar Net
Fault Ride Through:	Status – Default setting: OFF If the function is activated, the inverter does not switch off immediately in the event of a short-term AC voltage dip (outside of the limits specified by the grid supplier), but instead continues to feed in power for a defined period.
	DB min – Default setting: 90% "Dead Band Minimum" setting in per cent
	DB max - Default setting: 120% "Dead Band Maximum" setting in per cent
	k-Fac. - Default setting: 0

Version	Displays the version and serial numbers of the PC boards in the inverter (e.g. for service purposes)
Display area	Display / Display Software / Integrity Checksum / Memory Card / Memory Card #1 / Power Stage / Power Stage Software / EMI Filter / Power Stage #3 / Power Stage #4

Switching the key lock on and off

General

The inverter has a key lock function. When the key lock is active, the Setup menu is not accessible, i.e. the setup data cannot be changed accidentally (or maliciously). The code 12321 has to be entered in order to activate / deactivate the key lock.

Switching the key lock on and off



- ↑ **1** Press the 'Menu' key

The menu level appears.

- 2** Press the unassigned 'Menu / Esc' key 5 times



"Access Code" is displayed in the "CODE" menu; the first digit starts flashing.

- + - **3** Enter the code 12321: use the 'Up' and 'Down' keys to select a value for the first digit of the code.

- ↵ **4** Press the 'Enter' key

The second digit starts flashing.

- 5** Repeat steps 3 and 4 for the second, third, fourth and fifth digit of the access code until ...

the selected code starts flashing.

- ↵ **6** Press the 'Enter' key

'Key Lock' is displayed in the 'LOCK' menu.

- + - **7** Use the 'Up' and 'Down' keys to turn the key lock on or off:

ON = key lock is on (the Setup menu is not accessible)

OFF = key lock is off (the Setup menu is accessible)

- ↵ **8** Press the 'Enter' key

USB Stick as a Data Logger and for Updating Inverter Software

USB flash drive as a datalogger

If a USB flash drive is connected to the USB A socket it can function as a datalogger for an inverter.

At any time, the logging data stored on the USB flash drive can be

- imported into the Fronius Solar.access software using the FLD file that was logged at the same time,
- viewed directly in third-party programs (e.g. Microsoft® Excel) using the CSV file logged at the same time.

Older versions (before Excel 2007) are limited to a maximum of 65,536 rows.

Further information on "Data on a USB flash drive", "Data volume and storage capacity" as well as "Buffer memory" can be found at:

Fronius Symo 3 - 10 kW:



→ <http://www.fronius.com/QR-link/4204260172EN>

Fronius Symo 10 - 20 kW, Fronius Eco:



→ <http://www.fronius.com/QR-link/4204260175EN>

Suitable USB flash drives

Due to the variety of USB flash drives available on the market, it cannot be guaranteed that every USB flash drive will be detected by the inverter.

Fronius recommends that only certified USB flash drives suitable for building sites are used (look out for the USB-IF logo).

The inverter supports USB flash drives with the following file systems:

- FAT12
- FAT16
- FAT32

Fronius recommends that the USB flash drives employed should only be used for recording logging data or updating the inverter software. The USB flash drives should not contain any other data.

USB symbol on the inverter display, e.g. in display mode 'NOW':

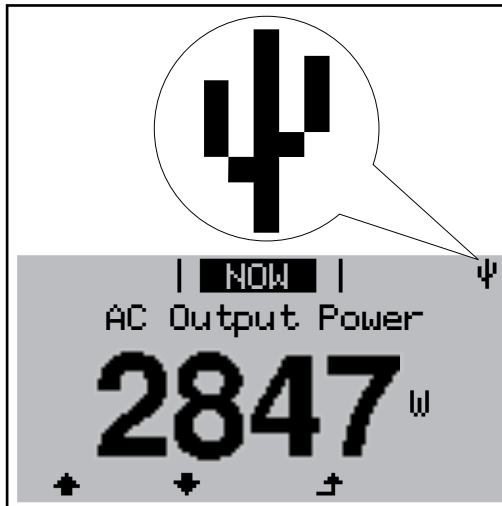

If the inverter detects a USB flash drive, the USB symbol will appear in the top right corner of the display.

When inserting a USB flash drive, check whether the USB symbol is displayed (it may also flash).



NOTE! Please note for outdoor applications that conventional USB flash drives are often only guaranteed to work within a restricted temperature range. For outdoor applications ensure that the USB flash drive also functions, for example, at low temperatures.

USB flash drive for updating the inverter software

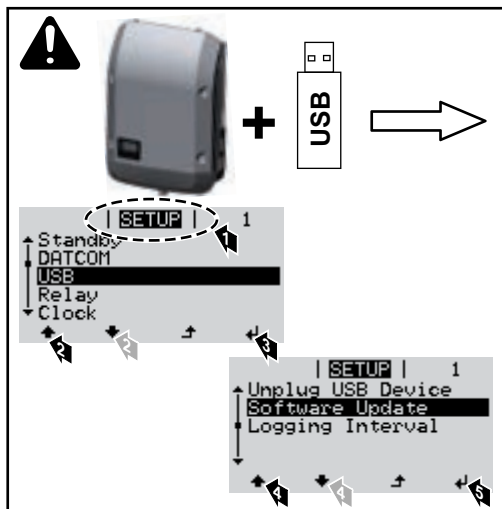

With the help of the USB flash drive, end customers can also update the inverter software via the SETUP menu: the update file is first saved to the USB flash drive, from where it is then transferred to the inverter.

Remove USB stick

Security note concerning the removal of a USB stick:

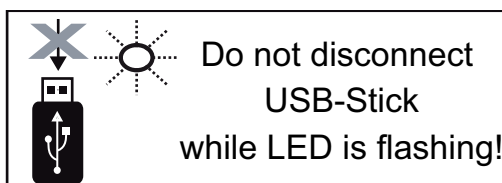

IMPORTANT! To avoid any loss of data, a USB stick may only be removed if the following conditions are met:

- only remove a USB stick via the 'Safely remove USB / HW' item on the SETUP menu
- the 'Data transmission' LED has stopped flashing or comes on steady.

The Basic menu

Access the Basic menu



- **1** Press the "Menu" key

The menu level appears.

- 2** Press the unassigned 'Menu / Esc' key 5 times



'Access Code' is displayed in the 'CODE' menu; the first digit starts flashing.

- + - **3** Enter the code 22742: Use the 'Up' and 'Down' keys to select a value for the first digit of the code

- ↵ **4** Press 'Enter'

The second digit flashes.

- 5** Repeat steps 3 and 4 for the second, third, fourth and fifth digit of the access code until...

the selected code starts flashing.

- ↵ **6** Press 'Enter'

The Basic menu appears.

- + - **7** Use the 'Up' or 'Down' keys to select the desired menu item

- ↵ **8** Press the 'Enter' key to open the desired menu item

- **9** Press the 'Esc' key to exit the Basic menu

Items on the Basic menu

The Basic menu is used to set the following parameters, which are important for installing and operating the inverter:

MPP Tracker 1 / MPP Tracker 2

- MPP Tracker 2: ON / OFF (MultiMPP Tracker devices only, excluding Fronius Symo 15.0-3 208)
- DC operating mode: MPP AUTO / FIX / MPP USER
 - MPP AUTO: normal operating status; the inverter automatically searches for the ideal operating point
 - FIX: for entering a fixed DC voltage at which the inverter will operate
 - MPP USER: for entering a lower MP voltage above which the inverter will search for its ideal operating point
- Dynamic Peak Manager: ON / OFF
- Fixed voltage: for entering the fixed voltage
- MPPT start voltage: for entering the start voltage

USB log book

Activates or deactivates the function for saving all error messages to a USB flash drive
AUTO / OFF / ON

Input signal

- How it works: Ext Sig. / S0-Meter / OFF
Only with the Ext Sig. function selected:
 - Triggering method: Warning (warning shown on display) / Ext. Stop (inverter switches off)
 - Connection type: N/C (normally closed contact) / N/O (normally open contact)

SMS / relay

- Event delay
For entering the time delay after which an SMS is sent or the relay is to switch
900 - 86,400 seconds
- Event counter:
For entering the number of events that lead to signalling:
10 - 255

Insulation setting

- Insulation warning: ON / OFF
- Threshold warning: for entering a threshold that leads to a warning
- Threshold fault: for entering a threshold that leads to a fault (not available in all countries)

TOTAL Reset

Under the LOG menu item, this setting resets the max. and min. voltage values and the max. power of feeding in to zero.

Once the values have been reset, this action cannot be undone.

To reset the values to zero, press the "Enter" key.

"CONFIRM" is displayed.

Press "Enter" again.

The values are reset and the menu is displayed.

Settings if the "DC OVP" option is installed

If the option: DC OVP (overvoltage protection) has been fitted in the inverter, the following menu items will be set by default:

Signal input: Ext Sig.
Triggering method: Warning
Connection type: N/C

Status diagnostics and troubleshooting

Displaying status codes The inverter performs a system self diagnosis that automatically detects many faults that may occur and shows them on the display. This means you are promptly made aware of malfunctions in the inverter and the photovoltaic system, or of any installation or operating faults.

If the system self diagnosis has detected a specific fault, the associated status code will be shown on the display.

IMPORTANT! Status codes may sometimes appear briefly as a result of the inverter's control response. If the inverter then continues working with no sign of any problem, this means that there was no fault.

Total failure of the display If the display fails to come on some time after sunrise:

- Check the AC voltage on the inverter connection sockets: the AC voltage must be 220/230 V (+ 10 % / - 5 %) or 380/400 V (+ 10 % / - 5 %).

Class 1 status codes Class 1 status codes generally only arise momentarily and are caused by the public grid.

Example: The grid frequency is too high and the inverter may not feed any energy into the grid owing to a standard. There is nothing wrong with the device. The initial response of the inverter is to disconnect itself from the grid. The grid is subsequently checked during the stipulated monitoring period. If no further problem has been detected by the end of this period, then the inverter will resume feeding energy into the grid.

The GPIS SoftStart function is activated according to the country setup: After cutting out due to an AC error, the output power of the inverter is continuously increased in line with the national guidelines.

Code	Description	Behaviour	Remedy
102	AC voltage too high		
103	AC voltage too low		
105	AC frequency too high	Following careful testing and when the grid conditions are within the permissible range again, the inverter will resume feeding energy into the grid.	Check grid connections; if this status code keeps recurring, contact your system engineer
106	AC frequency too low		
107	No AC grid		
108	Stand-alone operation detected		
112	RCMU error		

Class 3 status codes Class 3 includes status codes that may occur while feeding energy into the grid, but generally do not cause the process to be interrupted for any length of time.

The inverter disconnects automatically from the grid, the grid is then monitored as specified and the inverter attempts to resume feeding energy into the grid.

Code	Description	Behaviour	Remedy
301	Overcurrent (AC)	Short-term interruption while feeding energy into the grid. The inverter resumes its start-up routine.	*)
302	Overcurrent (DC)		
303	DC module overtemperature	Short-term interruption while feeding energy into the grid. The inverter resumes with its startup routine.	Purge cooling air openings and heat sink; **)
304	AC module overtemperature		
305	No power being fed in, despite closed relay	Short-term interruption while feeding energy into the grid. The inverter resumes with its startup routine.	**)
306	PV output too low for feeding energy into the grid	Short-term interruption while feeding energy into the grid. The inverter resumes its start-up routine.	wait for sufficient level of insolation; **)
307	DC low DC input voltage too low for feeding energy into the grid		
IMPORTANT! Due to the low level of insolation early in the morning and in the evening, the status codes 306 (Power low) and 307 (DC low) are displayed routinely at these times of day. These status codes do not indicate any kind of fault.			
308	Intermediate circuit voltage too high	Short-term interruption while feeding energy into the grid. The inverter resumes its start-up routine.	**)
309	DC input voltage MPPT 1 too high		
311	Polarity of DC strings reversed		
313	DC input voltage MPPT2 too high		
314	Current sensor calibration timeout	Short-term interruption while feeding energy into the grid. The inverter resumes with its startup routine.	*)
315	AC current sensor error		
316	InterruptCheck fail		
325	Overtemperature in the connection area		
326	Fan 1 error		
327	Fan 2 error		

*) If the status code is displayed all the time: notify a Fronius-trained service engineer

***) Fault is rectified automatically. If this status code keeps recurring, contact your system engineer

Status codes – Class 4 Some of the class 4 status codes necessitate intervention by a Fronius-trained service technician.

Code	Description	Behaviour	Remedy
401	Unable to communicate with the power stage set	The inverter will automatically attempt to connect again and, if possible, will resume feeding energy into the grid	*)
406	AC module temperature sensor faulty (L1)		
407	AC module temperature sensor faulty (L2)		
408	DC component measured in the grid too high		

Code	Description	Behaviour	Remedy
412	Fixed voltage mode has been selected instead of MPP voltage mode, and the fixed voltage has been set to too low or too high a value.	-	**)
415	Safety cut-out via option card or RECER-BO has triggered	The inverter is not feeding any energy into the grid.	*)
416	No communication possible between power stage set and control system.	The inverter will automatically attempt to connect again and, if possible, will resume feeding energy into the grid	*)
417	Hardware ID problem		
419	Unique ID conflict		
420	No communication possible with the Fronius Datamanager	The inverter will automatically attempt to connect again and, if possible, will resume feeding energy into the grid	Update inverter firmware; *)
421	HID range error		
425	Unable to communicate with the power stage set		
426 - 428	Possible hardware fault		
431	Software problem	The inverter is not feeding any energy into the grid.	Perform AC reset (switch automatic circuit breaker off and on again); update inverter firmware; *)
436	Functional incompatibility (one or more PC boards in the inverter are not compatible with each other, e.g. after a PC board has been replaced)	The inverter will automatically attempt to connect again and, if possible, will resume feeding energy into the grid	Update inverter firmware; *)
437	Power stage set problem		
438	Functional incompatibility (one or more PC boards in the inverter are not compatible with each other, e.g. after a PC board has been replaced)	The inverter will automatically attempt to connect again and, if possible, will resume feeding energy into the grid	Update inverter firmware; *)
443	Intermediate circuit voltage too low or asymmetric	The inverter is not feeding any energy into the grid.	*)
445	- Compatibility error (e.g. due to replacement of a PC board) - Invalid power stage set configuration	The inverter is not feeding any energy into the grid.	Update inverter firmware; *)
447	Insulation fault		
448	Neutral conductor not connected	The inverter is not feeding any energy into the grid.	*)
450	Guard cannot be found		

Code	Description	Behaviour	Remedy
451	Memory error detected		
452	Communication error between the processors		
453	Grid voltage and power stage set are incompatible	The inverter will automatically attempt to connect again and, if possible, will resume feeding energy into the grid	*)
454	Grid frequency and power stage set are incompatible		
456	Anti-islanding function is no longer being implemented correctly		
457	Grid relay is sticking or the neutral conductor ground voltage is too high		
458	Error when recording measuring signal		
459	Error when recording the measuring signal for the insulation test		
460	Reference voltage source for the digital signal processor (DSP) is working out of tolerance	The inverter is not feeding any energy into the grid.	*)
461	DSP data memory error		
462	Error during DC feed monitoring routine		
463	Reversed AC polarity, AC connector inserted incorrectly		
474	RCMU sensor faulty		
475	Insulation fault (connection between solar module and ground)	The inverter is not feeding any energy into the grid.	**)
476	Driver supply voltage too low		
479	Intermediate circuit voltage relay is switched off	The inverter will automatically attempt to connect again and, if possible, will resume feeding energy into the grid	*)
480, 481	Functional incompatibility (one or more PC boards in the inverter are not compatible with each other, e.g. after a PC board has been replaced)	The inverter is not feeding any energy into the grid.	Update inverter firmware; *)
482	Setup interrupted after initial start-up	The inverter is not feeding any energy into the grid.	Restart Setup after an AC reset (switch automatic circuit breaker off and on again)
483	Voltage $U_{DC\ fixed}$ on MPP2 string out of limits	The inverter is not feeding any energy into the grid.	Check MPP settings; *)
485	CAN transmit buffer is full	The inverter is not feeding any energy into the grid.	Perform AC reset (switch automatic circuit breaker off and on again); *)
489	Permanent overvoltage on intermediate circuit capacitor (five 479 status codes in a row)	The inverter is not feeding any energy into the grid.	*)

*) If the status code is displayed all the time: Notify a Fronius-trained service technician

***) If this status code keeps recurring, contact your system engineer.

**Status codes –
Class 5**

Class 5 status codes do not generally interfere with feeding energy into the grid, but can cause restrictions. These status codes are displayed until they are acknowledged by pressing a key (however, the inverter continues to operate normally in the background).

Code	Description	Behaviour	Remedy
502	Insulation error on the solar modules	Warning message is shown on the display	**)
509	No energy fed into the grid in the past 24 hours	Warning message is shown on the display	Acknowledge status code; check whether all the conditions for the problem-free feeding of energy into the grid have been met (e.g. are the solar modules covered with snow?); **)
515	Unable to communicate with filter	Warning message on the display	*)
516	No communication possible with the storage unit	Storage unit warning message	*)
517	Power derating caused by too high a temperature	When power derating occurs, a warning message is shown on the display.	If necessary, purge cooling air openings and heat sink; fault is rectified automatically; **)
518	Internal DSP malfunction	Warning message on the display	*)
519	No communication possible with the storage unit	Storage unit warning message	*)
520	No energy fed into the grid by MPPT1 in the past 24 hours	Warning message is shown on the display	Acknowledge status code; check whether all the conditions for the problem-free feeding of energy into the grid have been met (e.g. are the solar modules covered with snow?); *)
522	DC low String 1	Warning message on the display	*)
523	DC low String 2		
558, 559	Functional incompatibility (one or more PC boards in the inverter are not compatible with each other, e.g. after a PC board has been replaced)	Warning message on the display	Update inverter firmware; *)
560	Power derating caused by overfrequency	Displayed when grid frequency becomes excessively high. The power is reduced.	As soon as the grid frequency is back within the permissible range and the inverter has returned to normal operation, the fault is rectified automatically; **)
564	Functional incompatibility (one or more PC boards in the inverter are not compatible with each other, e.g. after a PC board has been replaced)	Warning message on the display	Update inverter firmware; *)
566	Arc detector switched off (e.g. during external arc monitoring)	The status code is displayed every day until the arc detector is reactivated.	No error Confirm status code by pressing 'Enter'
572	Power limited by the power stage set	Power is being limited by the power stage set	*)

Code	Description	Behaviour	Remedy
573	Undertemperature warning	Warning message on the display	*)
581	"Special Purpose Utility-Interactive" (SPUI) setup activated	The inverter is no longer compliant with the IEEE1547 and IEEE1574.1 standards because the standalone function has been deactivated, a frequency-dependent power reduction has been activated and the frequency and voltage limits are being changed	No error Confirm status code by pressing 'Enter'

*) If the status code is displayed all the time: Notify a Fronius-trained service engineer

**) If this status code keeps recurring, contact your system engineer.

Class 6 status codes Some of the class 6 status codes necessitate intervention by a Fronius-trained service engineer.

Code	Description	Behaviour	Remedy
601	CAN bus is full	The inverter is not feeding any energy into the grid.	Update inverter firmware; *)
603	AC module temperature sensor faulty (L3)	The inverter will automatically attempt to connect again and, if possible, will resume feeding energy into the grid	*)
604	DC module temperature sensor faulty		
607	RCMU error	The inverter is not feeding any energy into the grid.	Reset status code by pressing 'Enter'. The inverter resumes the feeding of energy into the grid; if the status code keeps appearing, check the complete photovoltaic system for damage; **)
608	Functional incompatibility (one or more PC boards in the inverter are not compatible with each other, e.g. after a PC board has been replaced)	The inverter is not feeding any energy into the grid.	Update inverter firmware; *)

*) If the status code is displayed all the time: notify a Fronius-trained service engineer

**) Fault is rectified automatically. If this status code keeps recurring, contact your system engineer

Status codes – Class 7 Class 7 status codes relate to the control system, the configuration and inverter data recording, and may directly or indirectly affect the process of feeding energy into the grid.

Code	Description	Behaviour	Remedy
701 - 704	Provides information about the internal processor status	Warning message on the display	*)
705	Conflict when setting the inverter number (e.g. number already assigned)	-	Correct inverter number in Setup menu
706 - 716	Provides information about the internal processor status	Warning message on the display	*)
721	EEPROM has been re-initialised	Warning message on the display	Acknowledge status code; *)
722 - 730	Provides information about the internal processor status	Warning message on the display	*)
731	Initialisation error - USB flash drive is not supported	Warning message on the display	Check or replace USB flash drive
732	Initialisation error - Overcurrent on USB flash drive	Warning message on the display	Check file system on USB flash drive; *)
733	No USB flash drive connected	Warning message on the display	Connect or check USB flash drive; *)
734	Update file not recognised or not present	Warning message on the display	Check update file (e.g. for correct file name) *)
735	Update file does not match the device, update file too old	Warning message on the display, update process is interrupted	Check update file and if necessary download an update file to match the device (e.g. at http://www.fronius.com); *)
736	Write or read error occurred	Warning message on the display	Check USB flash drive and the data contained on it or replace USB flash drive Never unplug a USB flash drive if the 'data transfer' LED is still flashing or lit; *)
737	File could not be opened	Warning message on the display	Remove and then reinsert USB flash drive; check or replace USB flash drive
738	Log file cannot be saved (e.g. USB flash drive is write-protected or full)	Warning message on the display	Create some storage space, remove write protection, if necessary check or replace USB flash drive; *)
740	Initialisation error - error in file system on USB flash drive	Warning message on the display	Check USB flash drive; reformat on PC for FAT12, FAT16 or FAT32
741	Error during recording of logging data	Warning message on the display	Remove and then reinsert USB flash drive; check or replace USB flash drive
743	Error occurred during update process	Warning message on the display	Repeat update process, check USB flash drive; *)
745	Update file corrupt	Warning message on the display, update process is interrupted	Download update file again; check or replace USB flash drive; *)
746	Error occurred during update process	Warning message on the display, update process is interrupted	Wait for two minutes, then start the update again; *)

Code	Description	Behaviour	Remedy
751	Time lost	Warning message on the display	Reset time and date on the inverter; *)
752	Real Time Clock module communication error		
753	Internal error: Real Time Clock module is in emergency mode	Time may be inaccurate or lost (feeding energy into the grid normal)	Reset time and date on the inverter
754 - 755	Provides information about the internal processor status	Warning message on the display	*)
757	Hardware error in the Real Time Clock module	Error message on the display; the inverter is not feeding any energy into the grid	*)
758	Internal error: Real Time Clock module is in emergency mode	Time may be inaccurate or lost (feeding energy into the grid normal)	Reset time and date on the inverter
760	Internal hardware error	Error message on the display	*)
761 - 765	Provides information about the internal processor status	Warning message on the display	*)
766	Emergency power limitation has been activated (max. 750 W)	Error message on the display	
767	Provides information about the internal processor status	Warning message on the display	*)
768	Different power limitation in the hardware modules		
772	Storage unit not available		
773	Software update group 0 (invalid country setup)	Warning message on the display	Press 'Enter' key to acknowledge error; *)
775	PMC power stage set not available		
776	Invalid device type	Warning message on the display	*)
781 - 794	Provides information about the internal processor status		

*) If the status code is displayed all the time: Notify a Fronius-trained service technician

Class 10 - 12 status codes

1000 - 1299- Provide information on the status of the internal processor program

Description

Is of no concern when the inverter is working properly and only appears in the "Status PS" setup parameter. In the event of an actual error, this status code assists Fronius Technical Support during the error analysis.

Customer service

IMPORTANT! Contact your Fronius dealer or a Fronius-trained service technician if

- an error appears frequently or all the time
- an error appears that is not listed in the tables

**Operation in
dusty environ-
ments**

When operating the inverter in extremely dusty environments:
when necessary, clean the cooling elements and fan on the back of the inverter as well as
the air intakes at the wall bracket using clean compressed air.

Technical data

Fronius Symo	3.0-3-S	3.7-3-S	4.5-3-S
Input data			
MPP voltage range	200 - 800 V DC	250 - 800 V DC	300 - 800 V DC
Max. input voltage (at 1,000 W/m ² / -10 °C in an open circuit)	1000 V DC		
Min. input voltage	150 V DC		
Max. input current	16.0 A		
Max. short circuit current of the solar modules (I _{SC PV})	24.0 A		
Max. feedback current ⁴⁾	32 A (RMS) ⁵⁾		
Output data			
Nominal output power (P _{nom})	3000 W	3700 W	4500 W
Max. output power	3000 W	3700 W	4500 W
Nominal grid voltage	3~ NPE 400 / 230 V or 3~ NPE 380 / 220 V		
Min. grid voltage	150 V / 260 V		
Max. grid voltage	280 V / 485 V		
Nominal output current at 220 / 230 V	4.5 / 4.3 A	5.6 / 5.4 A	6.8 / 6.5 A
Max. output current	9 A		
Nominal frequency	50 / 60 Hz ¹⁾		
Total harmonic distortion	< 3%		
cos phi power factor	0.7 - 1 ind./cap. ²⁾		
Power-up current pulse ⁶⁾ and duration	38 A / 2 ms		
Max. output fault current per period	21.4 A / 1 ms		
General data			
Maximum efficiency	98%		
European efficiency	96.2%	96.7%	97%
Overnight self-consumption	< 0.7 W & < 3 VA		
Cooling	Controlled forced-air ventilation		
Degree of protection	IP 65		
Dimensions h x w x d	645 x 431 x 204 mm		
Weight	16 kg		
Permissible ambient temperature	- 25 °C - +60 °C		
Permitted humidity	0 - 100%		
EMC device class	B		
Overvoltage category DC / AC	2 / 3		
Pollution level	2		
Noise emission	58.3 dB(A) ref. 1pW		
Protection devices			
DC insulation measurement	Integrated		
Response to DC overload	Operating point shift, power limitation		
DC disconnecter	Integrated		
RCMU	Integrated		

Fronius Symo	3.0-3-M	3.7-3-M	4.5-3-M
Input data			
MPP voltage range	150 - 800 V DC	150 - 800 V DC	150 - 800 V DC
Max. input voltage (at 1,000 W/m ² / -10 °C in an open circuit)	1000 V DC		
Min. input voltage	150 V DC		
Max. input current	2 x 16.0 A		
Max. short circuit current of the solar modules (I _{SC PV})	2 x 24.0 A		
Max. feedback current ⁴⁾	48 A (RMS) ⁵⁾		
Output data			
Nominal output power (P _{nom})	3000 W	3700 W	4500 W
Max. output power	3000 W	3700 W	4500 W
Nominal grid voltage	3~ NPE 400 / 230 V or 3~ NPE 380 / 220		
Min. grid voltage	150 V / 260 V		
Max. grid voltage	280 V / 485 V		
Nominal output current at 220 / 230 V	4.6 / 4.4 A	5.6 / 5.4 A	6.8 / 6.5 A
Max. output current	13.5 A		
Nominal frequency	50 / 60 Hz ¹⁾		
Total harmonic distortion	< 3%		
cos phi power factor	0.85 - 1 ind./cap. ²⁾		
Power-up current pulse ⁶⁾ and duration	38 A / 2 ms		
Max. output fault current per period	24 A / 6.6 ms		
General data			
Maximum efficiency	98%		
European efficiency	96.5%	96.9%	97.2%
Overnight self-consumption	< 0.7 W & < 3 VA		
Cooling	Controlled forced-air ventilation		
Degree of protection	IP 65		
Dimensions h x w x d	645 x 431 x 204 mm		
Weight	19.9 kg		
Permissible ambient temperature	- 25 °C - +60 °C		
Permitted humidity	0 - 100%		
EMC device class	B		
Overvoltage category DC / AC	2 / 3		
Pollution level	2		
Noise emission	59.5 dB(A) ref. 1pW		
Protection devices			
DC insulation measurement	Integrated		
Response to DC overload	Operating point shift, power limitation		
DC disconnecter	Integrated		
RCMU	Integrated		

Fronius Symo	5.0-3-M	6.0-3-M	7.0-3-M
Input data			
MPP voltage range	163 - 800 V DC	195 - 800 V DC	228 - 800 V DC
Max. input voltage (at 1,000 W/m ² / -10 °C in an open circuit)	1000 V DC		
Min. input voltage	150 V DC		
Max. input current	2 x 16.0 A		
Max. short circuit current of the solar modules (I _{SC PV})	2 x 24.0 A		
Max. feedback current ⁴⁾	48 A (RMS) ⁵⁾		
Output data			
Nominal output power (P _{nom})	5000 W	6000 W	7000 W
Max. output power	5000 W	6000 W	7000 W
Nominal grid voltage	3~ NPE 400 / 230 V or 3~ NPE 380 / 220		
Min. grid voltage	150 V / 260 V		
Max. grid voltage	280 V / 485 V		
Nominal output current at 220 / 230 V	7.6 / 7.3 A	9.1 / 8.7 A	10.6 / 10.2 A
Max. output current	13.5 A		
Nominal frequency	50 / 60 Hz ¹⁾		
Total harmonic distortion	< 3%		
cos phi power factor	0.85 - 1 ind./cap. ²⁾		
Power-up current pulse ⁶⁾ and duration	38 A / 2 ms		
Max. output fault current per period	24 A / 6.6 ms		
General data			
Maximum efficiency	98%		
European efficiency	97.3%	97.5%	97.6%
Overnight self-consumption	< 0.7 W & < 3 VA		
Cooling	Controlled forced-air ventilation		
Degree of protection	IP 65		
Dimensions h x w x d	645 x 431 x 204 mm		
Weight	19.9 kg	19.9 kg	21.9 kg
Permissible ambient temperature	- 25 °C - +60 °C		
Permitted humidity	0 - 100%		
EMC device class	B		
Overvoltage category DC / AC	2 / 3		
Pollution level	2		
Noise emission	59.5 dB(A) ref. 1pW		
Protection devices			
DC insulation measurement	Integrated		
Response to DC overload	Operating point shift, power limitation		
DC disconnecter	Integrated		
RCMU	Integrated		

Fronius Symo	8.2-3-M
Input data	
MPP voltage range (PV1 / PV2)	267 - 800 V DC
Max. input voltage (at 1,000 W/m ² / -10 °C in an open circuit)	1000 V DC
Min. input voltage	150 V DC
Max. input current (I PV1 / I PV2)	2 x 16.0 A
Max. short circuit current of the solar modules (I _{SC PV})	2 x 24.0 A
Max. feedback current ⁴⁾	48 A (RMS) ⁵⁾
Output data	
Nominal output power (P _{nom})	8200 W
Max. output power	8200 W
Nominal grid voltage	3~ NPE 400 / 230 V or 3~ NPE 380 / 220
Min. grid voltage	150 V / 260 V
Max. grid voltage	280 V / 485 V
Nominal output current at 220 / 230 V	12.4 / 11.9 A
Max. output current	13.5 A
Nominal frequency	50 / 60 Hz ¹⁾
Total harmonic distortion	< 3%
cos phi power factor	0.85 - 1 ind./cap. ²⁾
Power-up current pulse ⁶⁾ and duration	38 A / 2 ms
Max. output fault current per period	24 A / 6.6 ms
General data	
Maximum efficiency	98%
European efficiency	97.7%
Overnight self-consumption	< 0.7 W & < 3 VA
Cooling	Controlled forced-air ventilation
Degree of protection	IP 65
Dimensions h x w x d	645 x 431 x 204 mm
Weight	21.9 kg
Permissible ambient temperature	- 25 °C - +60 °C
Permitted humidity	0 - 100%
EMC device class	B
Overvoltage category DC / AC	2 / 3
Pollution level	2
Noise emission	59.5 dB(A) ref. 1pW
Protection devices	
DC insulation measurement	Integrated
Response to DC overload	Operating point shift, power limitation
DC disconnecter	Integrated
RCMU	Integrated

Fronius Symo	10.0-3-M	12.5-3-M
Input data		
MPP voltage range	270 - 800 V DC	320 - 800 V DC
Max. input voltage (at 1,000 W/m ² / -10 °C in an open circuit)	1000 V DC	
Min. input voltage	200 V DC	
Max. input current (MPP1 / MPP2) (MPP1 + MPP2)	27.0 / 16.5 A (14 A for voltages < 420 V) 43.5 A	
Max. short circuit current of the solar modules (I _{SC PV}) (MPP1 / MPP2)	40.5 / 24.8 A	
Max. feedback current ⁴⁾	40.5 / 24.8 A (RMS) ⁵⁾	
Output data		
Nominal output power (P _{nom})	10,000 W	12,500 W
Max. output power	10,000 W	12,500 W
Nominal grid voltage	3~ NPE 400 / 230 V or 3~ NPE 380 / 220	
Min. grid voltage	150 V / 260 V	
Max. grid voltage	280 V / 485 V	
Nominal output current at 220 / 230 V	15.2 / 14.5 A	18.9 / 18.1 A
Max. output current	20 A	
Nominal frequency	50 / 60 Hz ¹⁾	
Total harmonic distortion	< 1.75%	< 2%
cos phi power factor	0 - 1 ind./cap. ²⁾	
Max. output fault current per period	64 A / 2.34 ms	
General data		
Maximum efficiency	97.8%	
European efficiency U _{DCmin} / U _{DCnom} / U _{DCmax}	95.4 / 97.3 / 96.6%	95.7 / 97.5 / 96.9%
Overnight self-consumption	0.7 W & 117 VA	
Cooling	Controlled forced-air ventilation	
Degree of protection	IP 66	
Dimensions h x w x d	725 x 510 x 225 mm	
Weight	34.8 kg	
Permissible ambient temperature	- 25 °C - +60 °C	
Permitted humidity	0 - 100%	
EMC device class	B	
Overvoltage category DC / AC	2 / 3	
Pollution level	2	
Noise emission	65 dB(A) (ref. 1pW)	
Protection devices		
DC insulation measurement	Integrated	
Response to DC overload	Operating point shift, power limitation	
DC disconnecter	Integrated	
RCMU	Integrated	

Fronius Symo	15.0-3-M	17.5-3-M	20.0-3-M
Input data			
MPP voltage range	320 - 800 V DC	370 - 800 V DC	420 - 800 V DC
Max. input voltage (at 1,000 W/m ² / -10 °C in an open circuit)	1000 V DC		
Min. input voltage	200 V DC		
Max. input current (MPP1 / MPP2) (MPP1 + MPP2)	33.0 / 27.0 A 51.0 A		
Max. short circuit current of the solar modules (I _{SC PV}) (MPP1 / MPP2)	49.5 / 40.5 A		
Max. feedback current ⁴⁾	49.5 / 40.5 A		
Output data			
Nominal output power (P _{nom})	15,000 W	17,500 W	20,000 W
Max. output power	15,000 W	17,500 W	20,000 W
Nominal grid voltage	3~ NPE 400 / 230 V or 3~ NPE 380 / 220		
Min. grid voltage	150 V / 260 V		
Max. grid voltage	280 V / 485 V		
Nominal output current at 220 / 230 V	22.7 / 21.7 A	26.5 / 25.4 A	30.3 / 29 A
Max. output current	32 A		
Nominal frequency	50 / 60 Hz ¹⁾		
Total harmonic distortion	< 1.5%	< 1.5%	< 1.25%
cos phi power factor	0 - 1 ind./cap. ²⁾		
Max. output fault current per period	64 A / 2.34 ms		
General data			
Maximum efficiency	98%		
European efficiency U _{DCmin} / U _{DCnom} / U _{DCmax}	96.2 / 97.6 / 97.1%	96.4 / 97.7 / 97.2%	96.5 / 97.8 / 97.3%
Overnight self-consumption	0.7 W & 117 VA		
Cooling	Controlled forced-air ventilation		
Degree of protection	IP 66		
Dimensions h x w x d	725 x 510 x 225 mm		
Weight	43.4 kg / 43.2 kg		
Permissible ambient temperature	- 25 °C - +60 °C		
Permitted humidity	0 - 100%		
EMC device class	B		
Overvoltage category DC / AC	2 / 3		
Pollution level	2		
Noise emission	65 dB(A) (ref. 1pW)		
Protection devices			
DC insulation measurement	Integrated		
Response to DC overload	Operating point shift, power limitation		
DC disconnecter	Integrated		
RCMU	Integrated		

Fronius Eco	25.0-3-S	27.0-3-S
Input data		
MPP voltage range	580 - 850 V DC	580 - 850 V DC
Max. input voltage (at 1,000 W/m ² / -10 °C in an open circuit)	1000 V DC	
Min. input voltage	580 V DC	
Max. input current	44.2 A	47.7 A
Max. short circuit current of the solar modules (I _{SC PV})	71.6 A	
Max. feedback current ⁴⁾	48 A (RMS) ⁵⁾	
Initial input voltage	650 V DC	
Output data		
Nominal output power (P _{nom})	25,000 W	27,000 W
Max. output power	25,000 W	27,000 W
Nominal grid voltage	3~ NPE 400 / 230 V or 3~ NPE 380 / 220	
Min. grid voltage	150 V / 260 V	
Max. grid voltage	275 V / 477 V	
Nominal output current at 220 / 230 V	37.9 / 36.2 A	40.9 / 39.1 A
Max. output current	42 A	
Nominal frequency	50 / 60 Hz ¹⁾	
Total harmonic distortion	< 2%	
cos phi power factor	0 - 1 ind./cap. ²⁾	
Max. output fault current per period	46 A / 156.7 ms	
General data		
Maximum efficiency	98%	
European efficiency U _{DCmin} / U _{DCnom} / U _{DCmax}	97.99 / 97.47 / 97.07%	97.98 / 97.59 / 97.19%
Overnight self-consumption	0.61 W & 357 VA	
Cooling	Controlled forced-air ventilation	
Degree of protection	IP 66	
Dimensions h x w x d	725 x 510 x 225 mm	
Weight (light version)	35.69 kg (35.44 kg)	
Permissible ambient temperature	- 25 °C - +60 °C	
Permitted humidity	0 - 100%	
EMC device class	B	
Overvoltage category DC / AC	2 / 3	
Pollution level	2	
Noise emission	72.5 dB(A) (ref. 1 pW)	
Power-up current pulse ⁶⁾ and duration	65.7 A / 448 µs	
Protection devices		
Max. overcurrent protection	80 A	
DC insulation measurement	Integrated	
Response to DC overload	Operating point shift, power limitation	
DC disconnecter	Integrated	
DC overvoltage protection	Integrated	
RCMU	Integrated	

Fronius Symo dummy

Input data	Dummy 3 - 10 kW	Dummy 10 - 20 kW
Nominal grid voltage	1 ~ NPE 230 V	
Grid voltage tolerance	+10 / -5 % ¹⁾	
Nominal frequency	50 - 60 Hz ¹⁾	
General data		
Degree of protection	IP 65	IP 66
Dimensions h x w x d	645 x 431 x 204 mm	725 x 510 x 225 mm
Weight	11 kg	22 kg

Explanation of footnotes

- 1) The values stated are defaults; the inverter is configured specifically to suit the requirements of the relevant country.
- 2) Depending on the country setup or device-specific settings (ind. = inductive; cap. = capacitive)
- 3) PCC = interface to the public grid
- 4) Maximum current from the inverter to the solar module when an error occurs in the inverter
- 5) Guaranteed by the electrical configuration of the inverter
- 6) Current peak when switching on the inverter

Applicable standards and guidelines
CE mark

The devices comply with all the requisite and relevant standards and guidelines that form part of the relevant EU Directive, and are therefore permitted to display the CE mark.

Circuit to prevent stand alone operation

The inverter has an approved circuit to prevent stand alone operation.

Grid failure

The standard measurement and safety procedures integrated into the inverter ensure that in the event of a grid failure, the feed-in of energy is immediately interrupted (e.g. switch-off by the energy supplier or damage to lines).

Warranty terms and conditions, and disposal

Fronius manufacturer's warranty

Detailed, country-specific warranty terms are available on the internet:
www.fronius.com/solar/warranty

To obtain the full warranty period for your newly installed Fronius inverter or storage system, please register at: www.solarweb.com.

Disposal

If you decide in the future to replace your inverter, Fronius will take back the old device and arrange for it to be recycled in an appropriate manner.

Fronius International GmbH

Froniusplatz 1
4600 Wels
Austria

Hot contact

info@mdacapitalinvest.com
+420 773 988 087

www.mdacapitalinvest.com